



# Technical Data Sheet

## 3mm POWER LED

**31-01/B4C-AKNB**

### Features

- . High Flux Output.
- . Low Profile.
- . Low Thermal Resistance.
- . Low Power Consumption.
- . The product itself will remain within RoHS compliant version.
- . ESD-withstand voltage: up to 4KV.

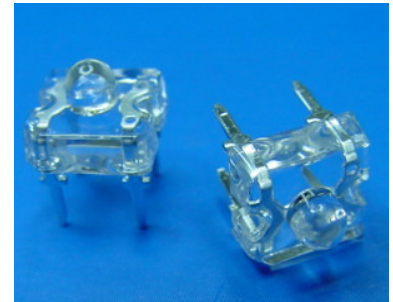

### Descriptions

This revolutionary package design allows the light designer to reduce the number of LEDs required and provide a more uniform and unique illuminated appearance than with other LED solutions. This is possible through the efficient optical package design and high-current capabilities.

The low profile package can be easily coupled with reflectors or lenses to efficiently distribute light and provide the desired light appearance.

### Applications

- . Automotive Exterior Lighting
- . Electronic Signs and Signals
- . Channel Letter
- . Special Lighting application

### Device Selection Guide

| PART NO.       | Chip     |               | Lens Color  |
|----------------|----------|---------------|-------------|
|                | Material | Emitted Color |             |
| 31-01/B4C-AKNB | InGaN    | Blue          | Water Clear |



# Technical Data Sheet

## 3mm POWER LED

**31-01/B4C-AKNB**

### Package Dimensions

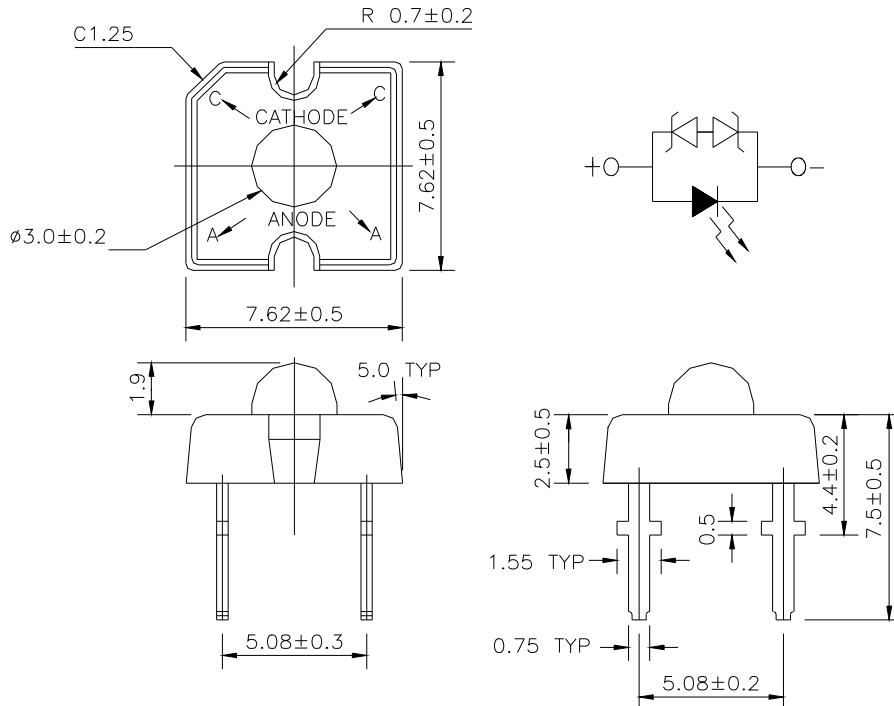

- Notes:**
1. All dimensions are in millimeters
  2. An epoxy meniscus may extend about 1.5mm(0.059") down the leads
  3. Tolerances unless dimensions  $\pm 0.25\text{mm}$

### Absolute Maximum Ratings ( $T_a=25^\circ\text{C}$ )

| Parameter                              | Symbol    | Rating     | Units            |
|--|-----------|------------|------------------|
| Continuous Forward Current             | $I_F$     | 30         | mA               |
| Peak Forward Current(Duty 1/10 @ 1KHZ) | $I_{FP}$  | 100        | mA               |
| Reverse Voltage                        | $V_R$     | 5          | V                |
| Operating Temperature                  | $T_{opr}$ | -40 ~ +85  | $^\circ\text{C}$ |
| Storage Temperature                    | $T_{stg}$ | -40 ~ +100 | $^\circ\text{C}$ |
| Soldering Temperature( $T=5$ sec)      | $T_{sol}$ | 260        | $^\circ\text{C}$ |
| Power Dissipation                      | $P_d$     | 120        | mW               |
| Zener Reverse Current                  | $I_Z$     | 100        | mA               |
| Electrostatic Discharge                | ESD       | 4K         | V                |



# Technical Data Sheet

## 3mm POWER LED

**31-01/B4C-AKNB**

### Electro-Optical Characteristics (Ta=25°C)

| Parameter                    | Symbol          | Min. | Typ. | Max. | Condition            | Unit |
|------------------------------|-----------------|------|------|------|----------------------|------|
| Total Flux                   | $\Phi_v$        | 1125 | ---- | 2850 | I <sub>F</sub> =30mA | mlm  |
| Viewing Angle                | $2\theta_{1/2}$ | ---- | 50   | ---- | I <sub>F</sub> =30mA | deg  |
| Peak Wavelength              | $\lambda_p$     | ---- | 468  | ---- | I <sub>F</sub> =30mA | Nm   |
| Dominant Wavelength          | $\lambda_d$     | 464  | 470  | 476  | I <sub>F</sub> =30mA | Nm   |
| Spectrum Radiation Bandwidth | $\Delta\lambda$ | ---- | 35   | ---- | I <sub>F</sub> =30mA | nm   |
| Forward Voltage              | V <sub>F</sub>  | 2.8  | 3.5  | 3.8  | I <sub>F</sub> =30mA | V    |
| Reverse Current              | I <sub>R</sub>  | ---- | ---- | 10   | V <sub>R</sub> =5V   | uA   |
| Zener Reverse Voltage        | V <sub>Z</sub>  | 5.2  | ---- | ---- | I <sub>Z</sub> =5mA  | V    |

### Rank

31-01/B4C-AKNB

(1)

(2)

(3)

| (1) V <sub>F</sub> (V) |      |      | (2) $\lambda_d$ |      |      | (3) $\Phi_v$ (mlm) |      |      |
|------------------------|------|------|-----------------|------|------|--------------------|------|------|
| Bin.                   | Min. | Max. | Bin.            | Min. | Max. | Bin.               | Min. | Max. |
| 0                      | 2.80 | 3.00 | 3               | 464  | 468  | K                  | 1125 | 1425 |
| 1                      | 3.00 | 3.20 | 4               | 468  | 472  | L                  | 1425 | 1800 |
| 2                      | 3.20 | 3.40 | 5               | 472  | 476  | M                  | 1800 | 2250 |
| 3                      | 3.40 | 3.60 |                 |      |      | N                  | 2250 | 2850 |
| 4                      | 3.60 | 3.80 |                 |      |      |                    |      |      |

\*Measurement Uncertainty of Forward Voltage : ±0.1V

\*Measurement Uncertainty of Total Flux : ±15%

\*Measurement Uncertainty of Dominant Wavelength : ±1.0nm



# Technical Data Sheet

## 3mm POWER LED

**31-01/B4C-AKNB**

### Typical Electro-Optical Characteristics Curves

**Relative Intensity vs. Wavelength**

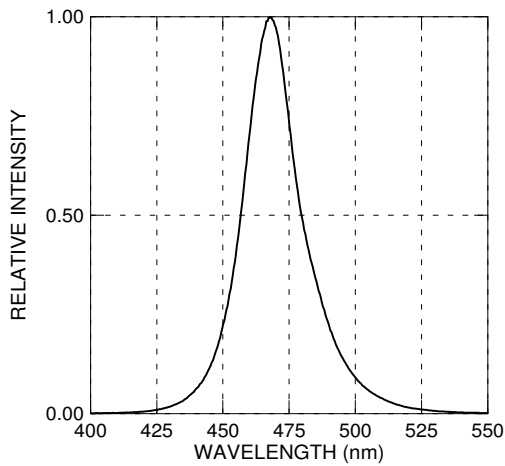

**Forward Current vs. Forward Voltage**

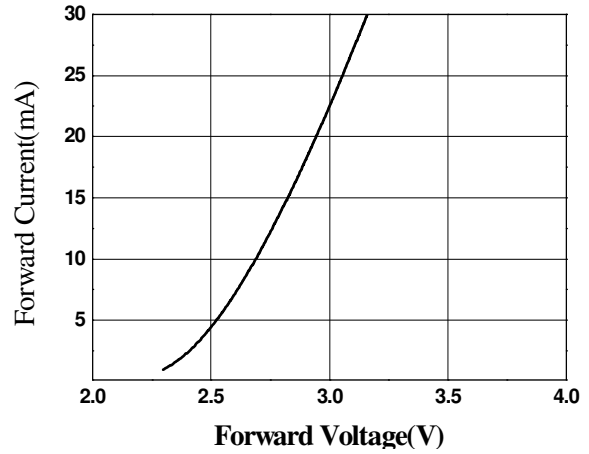

**Relative Intensity vs. Forward Current**

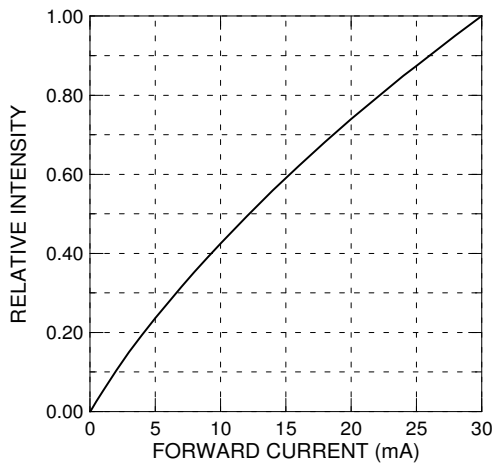

**Forward Current vs. Ambient Temp.**

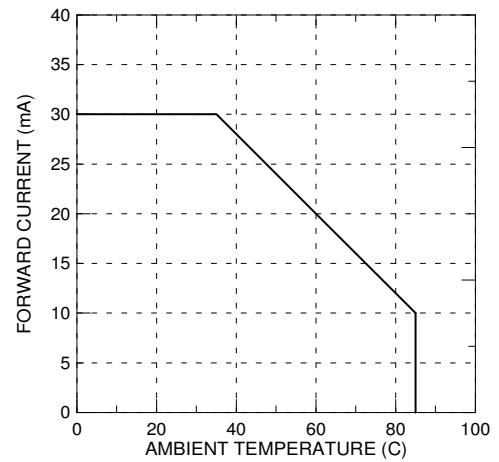

**Relative Intensity vs. Displacement Angle**

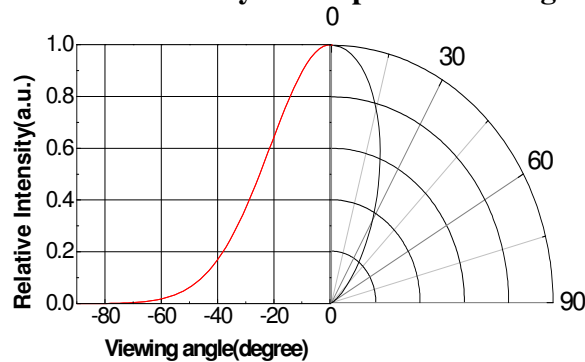

# Technical Data Sheet

## 3mm POWER LED

**31-01/B4C-AKNB**

### Packing Specification

#### 1. Tube

Cross section image of tube

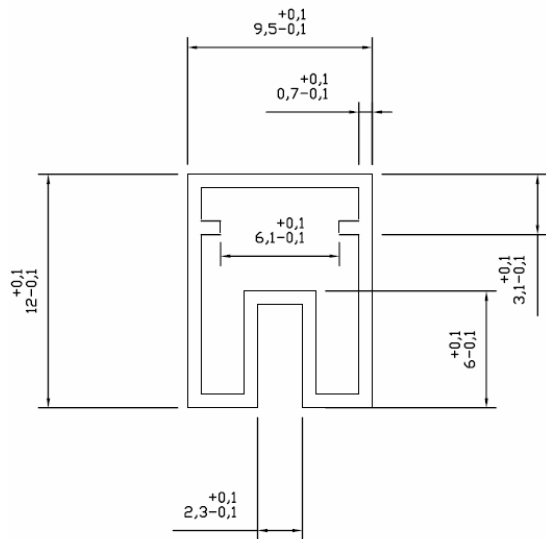

Unit: mm

Whole image of tube

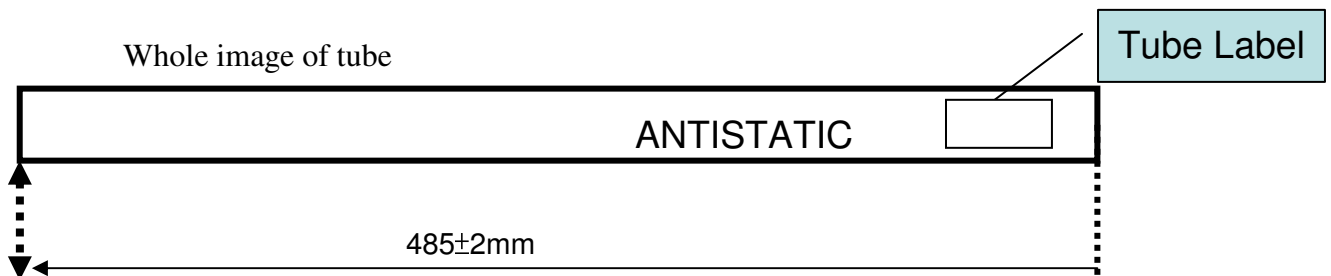

#### 2. Inner Box

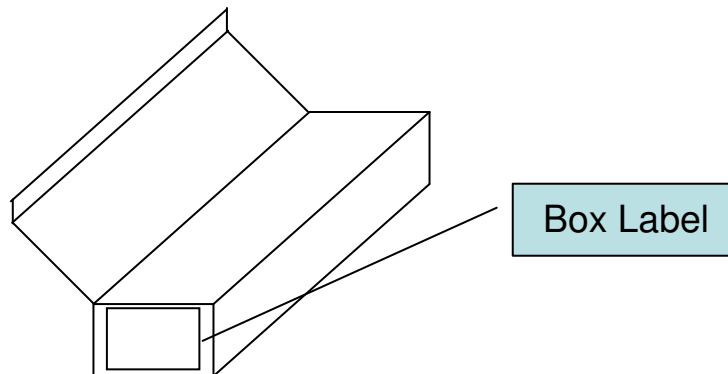



# Technical Data Sheet

## 3mm POWER LED

**31-01/B4C-AKNB**

### 3. Outside Box

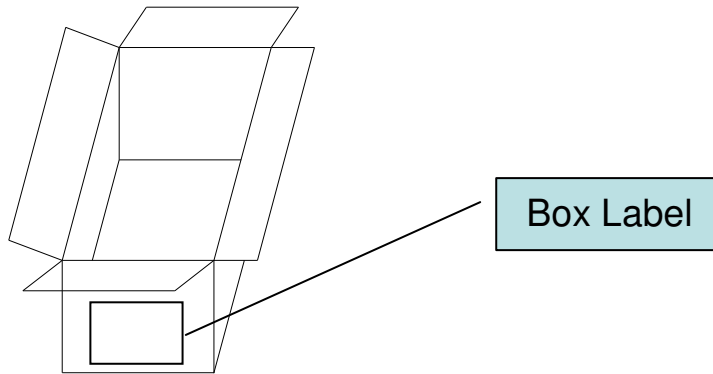

### Packing Quantity Specification

- (1) 60 pcs/1 tube, 30 tubes/1 small inside box, 12 small inside boxes/1 outside box
- (2) 60 pcs/1 tube, 105 tubes/1 big inside box, 4 big inside boxes/1 outside box

### Label Form Specification

(1) Tube Label Form

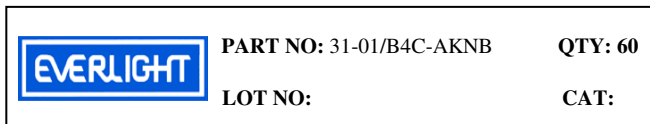

(2) Box Label Form

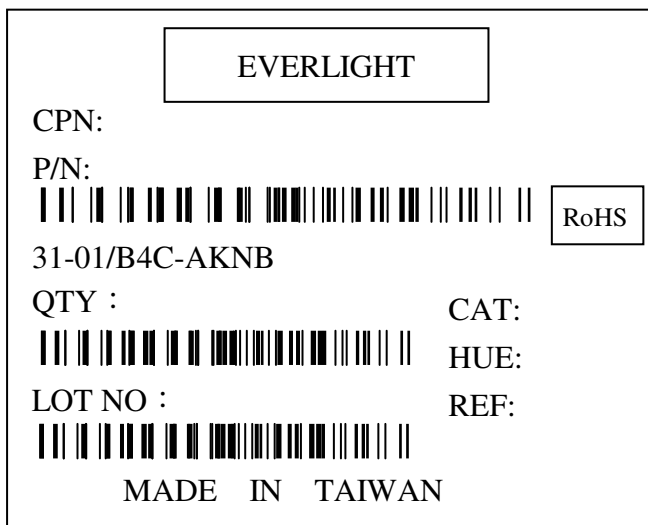

PART NO: Everlight's Production Number  
 QTY: Packing Quantity  
 LOT NO: Lot Number  
 CAT: Ranks of Forward Voltage, Color Bin  
 Grade and Total Flux  
 CPN: Customer's Production Number  
 P/N : Production Number  
 HUE: Reference  
 REF: Reference  
 MADE IN TAIWAN: Production Place



# Technical Data Sheet

## 3mm POWER LED

**31-01/B4C-AKNB**

### Notes

#### 1. Lead Forming

- During lead formation, the leads should be bent at a point at least 3mm from the base of the epoxy bulb.
- Lead forming should be done before soldering.
- Avoid stressing the LED package during leads forming. The stress to the base may damage the LED's characteristics or it may break the LEDs.
- Cut the LED leadframes at room temperature. Cutting the leadframes at high temperatures may cause failure of the LEDs.
- When mounting the LEDs onto a PCB, the PCB holes must be aligned exactly with the lead position of the LED. If the LEDs are mounted with stress at the leads, it causes deterioration of the epoxy resin and this will degrade the LEDs.

#### 2. Storage

- The LEDs should be stored at 30°C or less and 70%RH or less after being shipped from Everlight and the storage life limits are 3 months. If the LEDs are stored for 3 months or more, they can be stored for a year in a sealed container with a nitrogen atmosphere and moisture absorbent material.
- Please avoid rapid transitions in ambient temperature, especially, in high humidity environments where condensation can occur.

#### 3. Soldering

- Careful attention should be paid during soldering. Solder the LED no lower than 1.6mm from the base of stopper is recommended.
- Avoiding applying any stress to the lead frame while the LEDs are at high temperature particularly when soldering.
- Recommended soldering conditions:

| Hand Soldering       |  | DIP Soldering |  |
|----------------------|--|---------------|--|
| Temp. at tip of iron | 300°C Max. (30W Max.)                        | Preheat temp. | 100°C Max. (60 sec Max.)                     |
| Soldering time       | 3 sec Max.                                   | Bath temp.    | 260 Max.                                     |
| Distance             | No lower than 1.6mm from the base of stopper | Bath time.    | 5 sec Max.                                   |
|                      |  | Distance      | No lower than 1.6mm from the base of stopper |

## Technical Data Sheet

### 3mm POWER LED

---

#### 31-01/B4C-AKNB

- Dip and hand soldering should not be done more than one time.
- After soldering the LEDs, the epoxy bulb should be protected from mechanical shock or vibration until the LEDs return to room temperature.
- A rapid-rate process is not recommended for cooling the LEDs down from the peak temperature.
- Although the recommended soldering conditions are specified in the above table, dip or handsoldering at the lowest possible temperature is desirable for the LEDs.
- Wave soldering parameter must be set and maintain according to recommended temperature and dwell time in the solder wave.

#### 4. Cleaning

- When necessary, cleaning should occur only with isopropyl alcohol at room temperature for a duration of no more than one minute. Dry at room temperature before use.
- Do not clean the LEDs by the ultrasonic. When it is absolutely necessary, the influence of ultrasonic cleaning on the LEDs depends on factors such as ultrasonic power and the assembled condition. Ultrasonic cleaning shall be pre-qualified to ensure this will not cause damage to the LED

#### 5. Circuit Protection

- Below the zener reference voltage  $V_z$ , all the current flows through LED and as the voltage rises to  $V_z$ , the zener diode "breakdown." If the voltage tries to rise above  $V_z$  current flows through the zener branch to keep the voltage at exactly  $V_z$ .
- When the LED is connected using serial circuit, if either piece of LED is no light up but current can't flow through causing others to light down. In new design, the LED is parallel with zener diode. if either piece of LED is no light up but current can flow through causing others to light up.



# Technical Data Sheet

## 3mm POWER LED

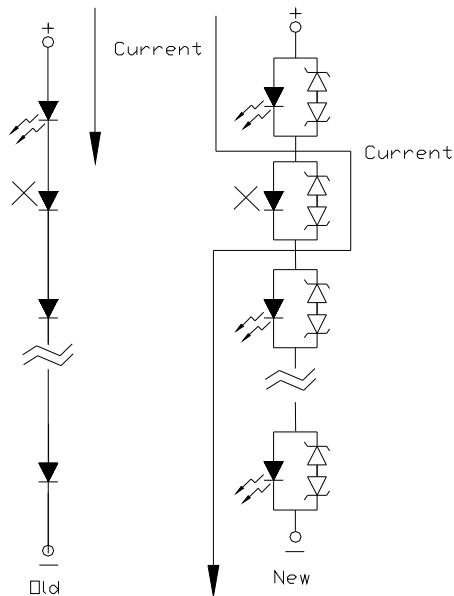
**31-01/B4C-AKNB**

### 6. Heat Management

- Heat management of LEDs must be taken into consideration during the design stage of LED application. The current should be de-rated appropriately by referring to the de-rating curve found in each product specification.
- The temperature surrounding the LED in the application should be controlled. Please refer to the data sheet de-rating curve.

### 7. ESD (Electrostatic Discharge)

- Electrostatic discharge (ESD) or surge current (EOS) can damage LEDs.
- An ESD wrist strap, ESD shoe strap or antistatic gloves must be worn whenever handling LEDs.
- All devices, equipment and machinery must be properly grounded.
- Use ion blower to neutralize the static charge which might have built up on surface of the LEDs plastic lens as a result of friction between LEDs during storage and handling.

### 8. Other

- Above specification may be changed without notice. EVERLIGHT will reserve authority on material change for above specification.
- When using this product, please observe the absolute maximum ratings and the instructions for using outlined in these specification sheets. EVERLIGHT assumes no responsibility for



# Technical Data Sheet

## 3mm POWER LED

---

### 31-01/B4C-AKNB

any damage resulting from use of the product which does not comply with the absolute maximum ratings and the instructions included in these specification sheets.

- These specification sheets include materials protected under copyright of EVERLIGHT corporation. Please don't reproduce or cause anyone to reproduce them without EVERLIGHT's consent.

**EVERLIGHT ELECTRONICS CO., LTD.**  
*Office: No 25, Lane 76, Sec 3, Chung Yang Rd,  
Tucheng, Taipei 236, Taiwan, R.O.C*

*Tel: 886-2-2267-2000, 2267-9936  
Fax: 886-2267-6244, 2267-6189, 2267-6306  
<http://www.everlight.com>*